

HS-U



- 定格電流値 …… 50A ~ 300A
Rated current …… 50A ~ 300A
- 応答性・直線性および温度特性に優れています
Superior in response, linearity and temperature characteristics
- 電圧出力と電流出力の両方を準備しました
Both the voltage output and the current output were prepared

用途 Applications

インバータ装置, サーボドライバ, 電源装置, NC工作機
Inverters, Servo drivers, Power supply equipment, NC machine tools

外形寸法図 Dimensions

(mm)

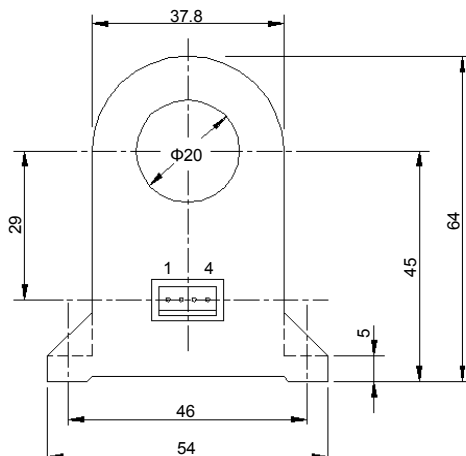
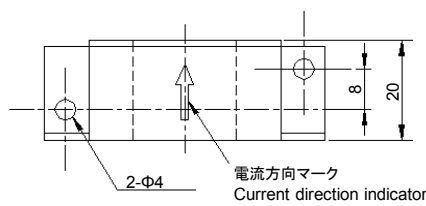

適合コネクタハウジング Supported connector housing
5051-04 (MOLEX)

端子番号 Terminal No.
1 …… 制御電源(+) (+) terminal
2 …… 制御電源(-) (-) terminal
3 …… 出力 Output
4 …… GND GND

質量 Weight : 43g

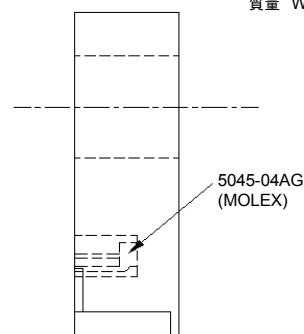

一般公差: ±0.5
General tolerance: ±0.5

電気特性 Specification

Ta=25°C

形名 (Type)	電圧出力タイプ (Voltage output type)			電流出力タイプ (Current output type)		
	HS-U050V4B15	HS-U100V4B15	HS-U300V4B15	HS-U050A005B15	HS-U100A005B15	HS-U300A015B15
定格電流 (Rated current) [If]	±50A	±100A	±300A	±50A	±100A	±300A
連続通電DC電流 (Continuously flowing DC current)	±50A	±100A	±150A	±50A	±100A	±300A
飽和電流 (Saturation current) [Is]	±150A	±300A	±390A	±150A	±300A	±300A
直線性範囲 (Linearity limits)	0~±150A	0~±300A	0~±360A	0~±150A (RL=50Ω)	0~±300A (RL=20Ω)	0~±300A (RL=20Ω)
定格出力 (Rated output) [Vh]	±4V±1% (RL=10kΩ)			±50mA±1%		±150mA±1%
残留出力 (Residual output) [V0]	Within ±20mV			Within ±0.2mA		
直線性 (Output linearity)	Within ±0.5%					
二次巻線抵抗 (Second coil resistance)	Approx. 25Ω	Approx. 50Ω		Approx. 25Ω	Approx. 50Ω	
応答速度 (Response time)	Within 1μs (The smaller one on either at di/dt = 100A/μs or If/μs.)					
過渡特性 (Response performance)	Within 10%					
ヒステリシス巾 (Hysteresis voltage range)	Within 20mV			Within 0.2mA		
出力温度特性 (Output Temp. Coef.)	Within ±0.02%/°C					
残留出力温度特性 (Residual output Temp. Coef.)	Within ±1mV/°C			Within ±0.01mA/°C		
制御電源 (Control power supply)	±15V±5%					
消費電流 (Consumption current)	20mA+(Input current/1000)	20mA+(Input current/2000)	20mA+(Input current/1000)	20mA+(Input current/2000)		
使用温度範囲 (Operating Temp.)	-10°C~+80°C					
保存温度範囲 (Storage Temp.)	-15°C~+85°C					
耐電圧 (Dielectric withstand voltage)	2500V AC 50/60Hz 1minute					
絶縁抵抗 (Insulation resistance)	Not less than 500MΩ 500V DC					

Note1) 残留出力値はコアヒステリシス除去後の値です。 The indicated residual output is the one after the core hysteresis is removed.

Note2) 飽和電流の通電時間は1秒以内のこと。 Energization time of saturation current shall be within 1 second.

Note3) 連続通電DC電流×150%の通電時間は1分以内のこと。

Energization time of continuous live DC current x150% shall be within 1 minute.

特性図 Characteristics chart

HS-U100A005B15 (RL=20Ω)

時間軸 Time base: 5μs/div.

パルス電流応答特性
Pulse current response characteristic

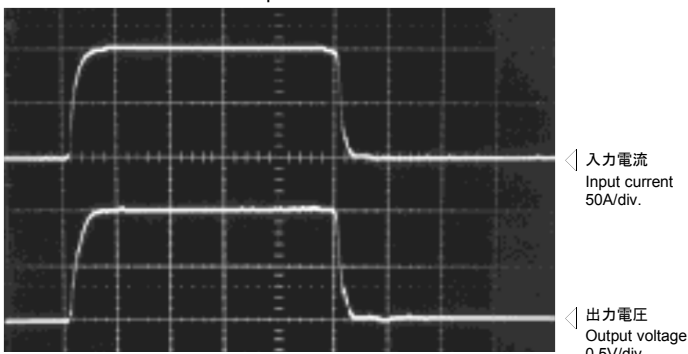

ノイズ特性 (dv/dtの影響)
Noise characteristics (Effects of dv/dt)

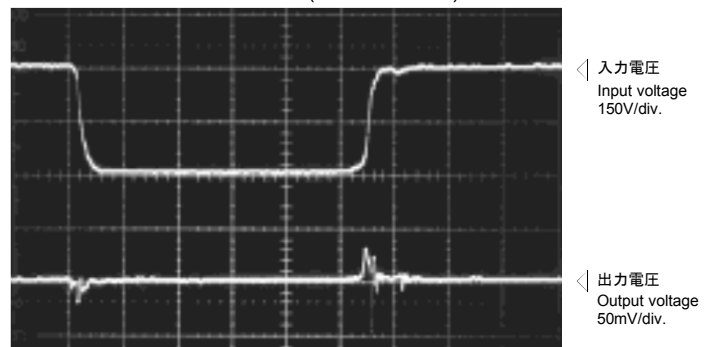

ノイズ特性 (インパルスノイズの影響)
Noise characteristics (Effects of impulse noise)

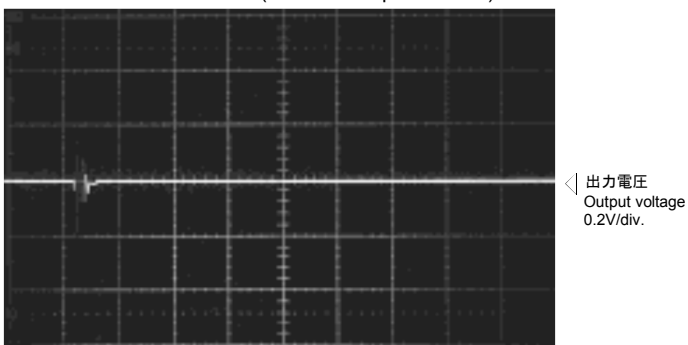

負荷抵抗-出力特性 (電流出力タイプ)
Load resistance-output characteristics (Current output type) Ta=25°C

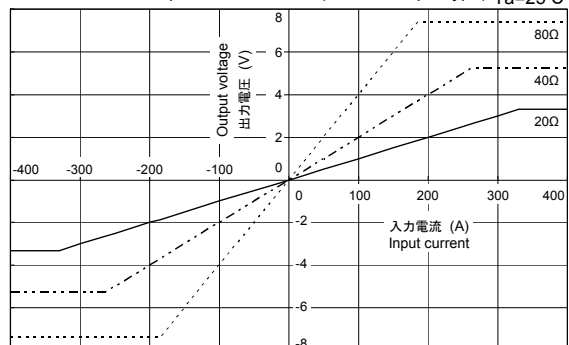

注: "◁"は0Vまたは、0Aを示します。 The marks "◁" means 0V or 0A.