

HC-U



- 定格電流値 … 50A ~ 300A
- Rated current … 50A ~ 300A

用途 Applications

インバータ装置, 電源装置, NC工作機, 溶接機
Inverters, Power supply equipment, NC machine tools, Welders

外形寸法図 Dimensions

(mm)

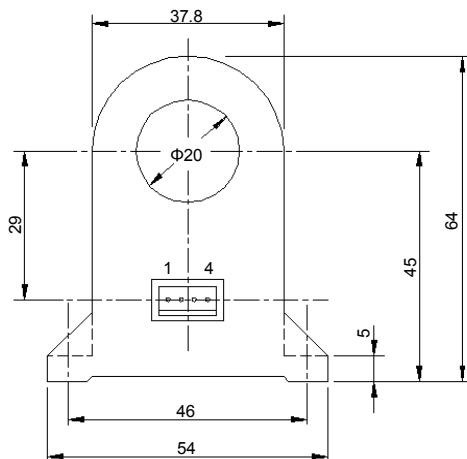
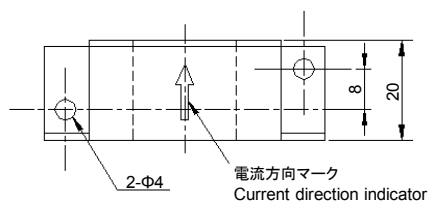

適合コネクタハウジング Supported connector housing
5051-04 (MOLEX)

- 端子番号 Terminal No.
- 1 … 制御電源(+) (+) terminal
 - 2 … 制御電源(-) (-) terminal
 - 3 … 出力 Output
 - 4 … GND GND

質量 Weight : 59g

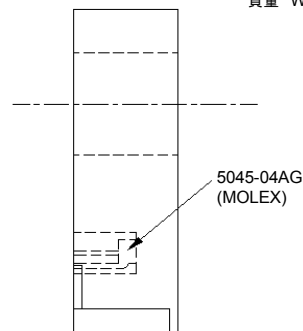

一般公差: ±0.5
General tolerance: ±0.5

電気特性 Specification

Ta=25°C

形名 (Type)	HC-U050V4B15	HC-U100V4B15	HC-U300V4B15
定格電流 (Rated current) [If]	±50A	±100A	±300A
飽和電流 (Saturation current) [Is]	±150A	±300A	±700A
直線性範囲 (Linearity limits)	0~±150A	0~±300A	0~±600A
定格出力 (Rated output) [Vh]	±4V±1.5%	±4V±1%	
残留出力 (Residual output) [Vo]	Within ±50mV	Within ±30mV	
直線性 (Output linearity)	Within ±1%		
応答速度 (Response time)	Within 10µs (The smaller one on either at di/dt = 100A/µs or If/µs.)		
過渡特性 (Response performance)	Within 10%		
ヒステリシス巾 (Hysteresis voltage range)	Within 30mV		
出力温度特性 (Output Temp. Coef.)	Within ±0.08%/°C		
残留出力温度特性 (Residual output Temp. Coef.)	Within ±2.5mV/°C	Within ±1.5mV/°C	
制御電源 (Control power supply)	±15V±5%		
消費電流 (Consumption current)	Within 30mA		
使用温度範囲 (Operating Temp.)	-10°C~+80°C		
保存温度範囲 (Storage Temp.)	-15°C~+85°C		
耐電圧 (Dielectric withstand voltage)	2500V AC 50/60Hz 1minute		
絶縁抵抗 (Insulation resistance)	Not less than 500MΩ 500V DC		

Note1) 定格出力値は無負荷時の値です。
The indicated rated output is the one when no load is applied.

Note2) 残留出力値はコアヒステリシス除去後の値です。
The indicated residual output is the one after the core hysteresis is removed.

特性図 Characteristics chart

HC-U100V4B15

時間軸 Time base: 5µs/div.

パルス電流応答特性
Pulse current response characteristic

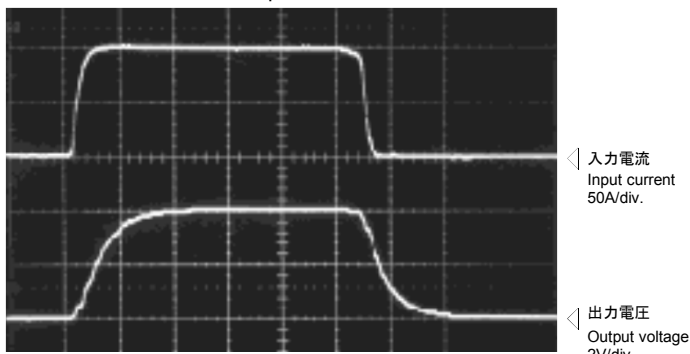

ノイズ特性 (dv/dtの影響)
Noise characteristics (Effects of dv/dt)

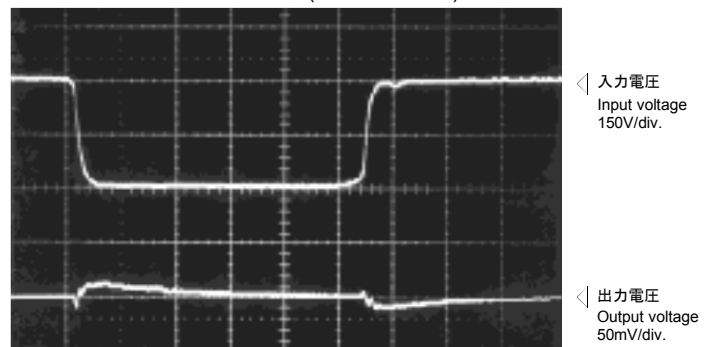

ノイズ特性 (インパルスノイズの影響)
Noise characteristics (Effects of impulse noise)

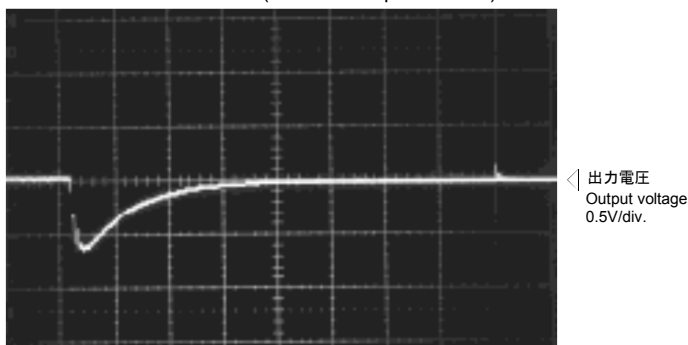

入-出力特性
Input/output characteristics

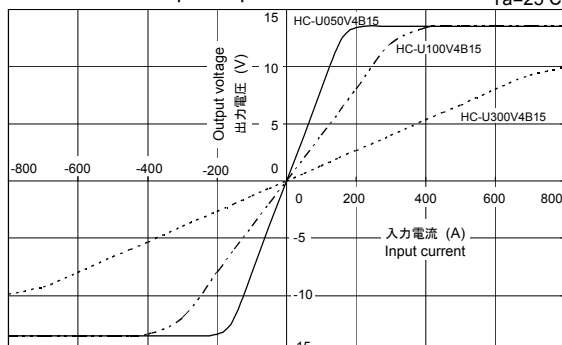

注: "◀"は0Vまたは、0Aを示します。 The marks "◀" means 0V or 0A.