

HC-TNR



- 定格電流値 …… 50A ~ 800A  
Rated current …… 50A ~ 800A
- 耐ノイズ特性に優れています  
Superior noise-resistance
- 従来品 (HC-TN) より低背化  
Low-profile realized to our conventional products (HC-TN)
- 欧州規格対応絶縁強化品  
Well isolated for European Standards
- シャーシ取付タイプ  
Chassis mounting type

用途 Applications

インバータ装置, サーボドライバ, 電源装置, UPS, NC工作機, 溶接機

Inverters, Servo drivers, Power supply equipment, Uninterruptible power supply (UPS), NC machine tools, Welders

外形寸法図 Dimensions

(mm)

- 端子番号 1 …… 制御電源(+) (+) terminal  
Terminal No. 2 …… 制御電源(-) (-) terminal  
3 …… 出力 Output  
4 …… GND

質量 Weight : 39g

SM04B-PASS(LF)(SN)  
(JST)

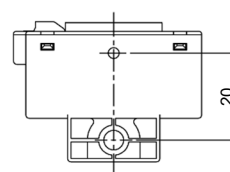
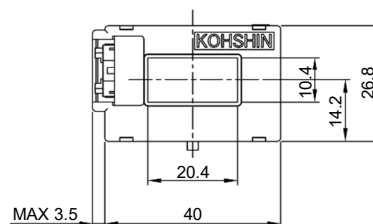
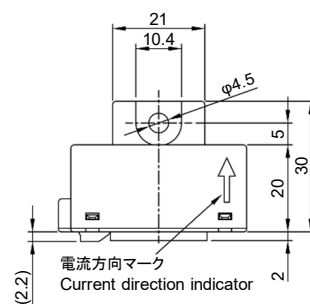
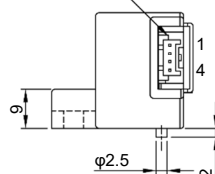

一般公差: ±0.5  
General tolerance: ±0.5

電気特性 Specification

Ta=25°C

形名 (Type)	HC-TNR050V4B15	HC-TNR100V4B15	HC-TNR300V4B15	HC-TNR600V4B15	HC-TNR800V4B15
定格電流 (Rated current) [If]	±50A	±100A	±300A	±600A	±800A
飽和電流 (Saturation current) [Is]	±150A	±300A	±900A	±1000A	±1000A
直線性範囲 (Linearity limits)	0~±150A	0~±300A	0~±700A	0~±900A	0~±900A
定格出力 (Rated output) RL=10kΩ [Vh]	V0±4V±1%				
残留出力 (Residual output) [V0]	Within ±50mV	Within ±30mV			
直線性 (Output linearity)	Within ±1%				
応答速度 (Response time)	Within 5μs (The smaller one on either at di/dt = 100A/μs or If/μs.)				
過渡特性 (Response performance)	Within 10%				
ヒステリシス巾 (Hysteresis voltage range)	Within 30mV				
出力温度特性 (Output Temp. Coef.)	Within ±0.1%/°C				
残留出力温度特性 (Residual output Temp. Coef.)	Within ±3mV/°C	Within ±1.5mV/°C	Within ±1mV/°C		
制御電源 (Control power supply)	±15V±5%				
消費電流 (Consumption current)	Within 20mA				
使用温度範囲 (Operating Temp.)	-25°C~+85°C				
保存温度範囲 (Storage Temp.)	-25°C~+85°C				
耐電圧 (Dielectric withstand voltage)	4000V AC 50/60Hz 1minute				
絶縁抵抗 (Insulation resistance)	Not less than 500MΩ 500V DC				

Note 1) 残留出力値はコアヒステリシス除去後の値です。  
The indicated residual output is the one after the core hysteresis is removed.

特性図 Characteristics chart

HC-TNR050V4B15

時間軸 Time base: 5μs/div.

パルス電流応答特性  
Pulse current response characteristic

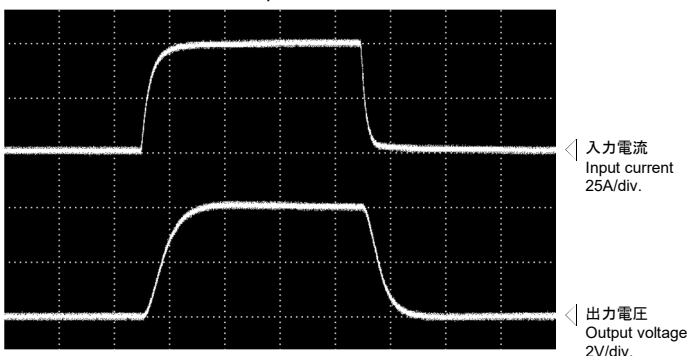

ノイズ特性 (dv/dtの影響)  
Noise characteristics (Effects of dv/dt)

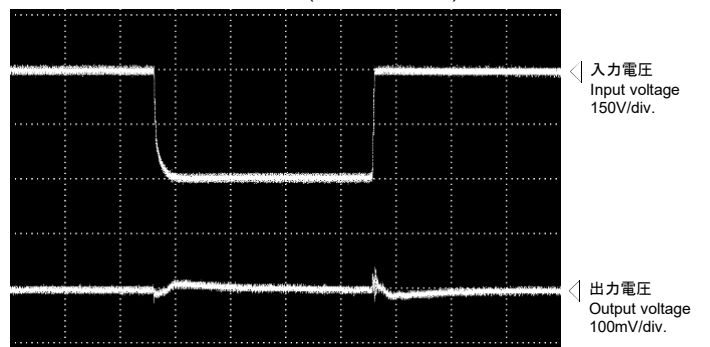

ノイズ特性 (インパルスノイズの影響)  
Noise characteristics (Effects of impulse noise)

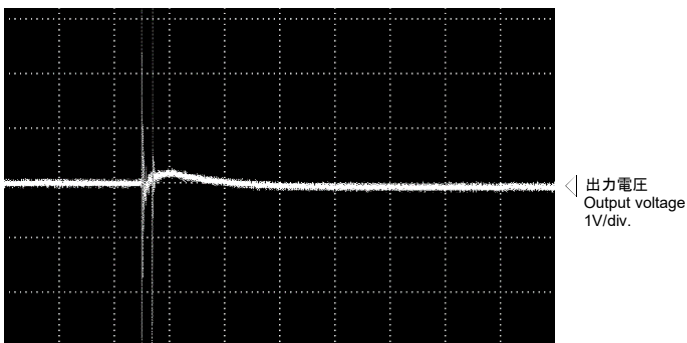

入-出力特性  
Input/output characteristics

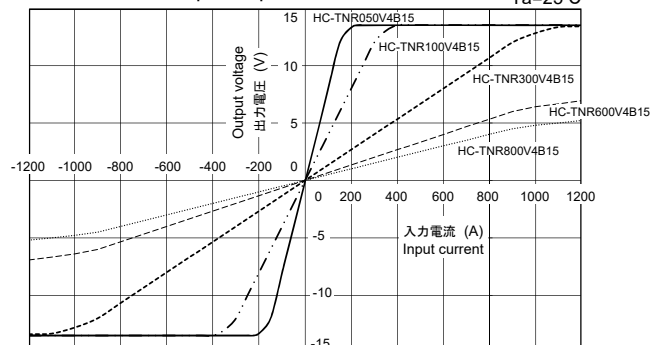

注: "◁" は0Vまたは、0Aを示します。 The marks "◁" means 0V or 0A.