

HC-PDG

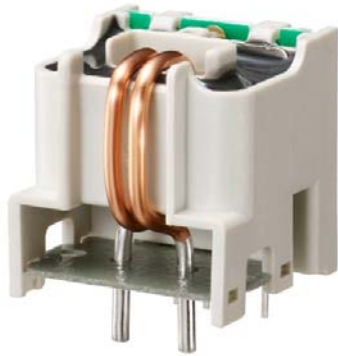

- 定格電流値 … 5A ~ 50A
Rated current … 5A ~ 50A
- 耐ノイズ特性に優れています
Superior noise-resistance
- 飽和特性に優れています
Superior saturation characteristics
- 高さを抑えたコンパクト設計
Reduced height compact design
- 片電源仕様の製作も可能です
Single-power supplies also available

用途 Applications

インバータ装置, サーボドライバ, 電源装置, UPS, NC工作機, 溶接機
Inverters, Servo drivers, Power supply equipment, Uninterruptible power supply (UPS), NC machine tools, Welders

外形寸法図 Dimensions

(mm)

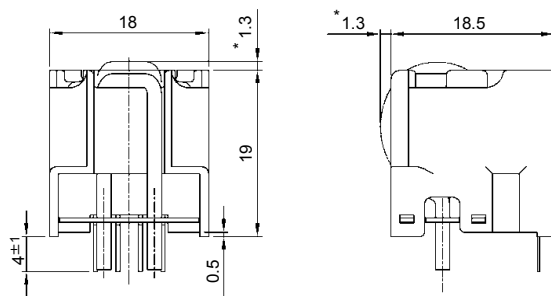

電流入力端子寸法
Dimensions of Current Input Terminals

1次巻線線径 Size of primary winding	D寸法 Width D
Φ0.8	Φ0.8
Φ1.0	Φ1.0
Φ1.1	Φ1.1
Φ1.3	Φ1.3
Φ1.6	Φ1.6

注) * 印寸法は1次巻線のみ出し最大値を示す
Note) Marking * mean maximum dimensions of primary winding protuberant.

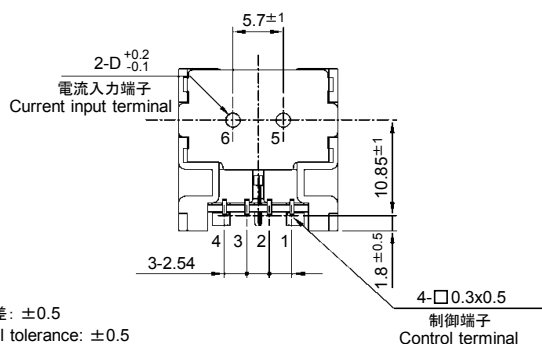

一般公差: ±0.5
General tolerance: ±0.5

- 端子番号 Terminal No.
- 1 … 制御電源(-) (-) terminal
 - 2 … GND
 - 3 … 制御電源(+) (+) terminal
 - 4 … 出力 Output
 - 5 … 電流入力(+) (+) input
 - 6 … 電流入力(-) (-) input

質量 Weight: 9g

電気特性 Specification

Ta=25°C

形名 (Type)	HC-PDG05V4B15	HC-PDG10V4B15	HC-PDG20V4B15	HC-PDG30V4B15	HC-PDG50V4B15
定格電流 (Rated current) [If]	±5A	±10A	±20A	±30A	±50A
連続通電DC電流 (Continuously flowing DC current)	±8.8A	±13.8A	±23.3A	±23.3A	±35.4A
飽和電流 (Saturation current) [Is]	±15A	±25A	±50A	±75A	±150A
直線性範囲 (Linearity limits)	0~±13.5A	0~±22.5A	0~±45A	0~±67.5A	0~±135A
1次巻線線径 (Size of primary winding)	Φ0.8	Φ1.0	Φ1.3	Φ1.3	Φ1.6
ターン数 (Turns)	10	6	3	2	1
定格出力 (Rated output) [Vh]	±4V±1.5% (RL=10kΩ)				
残留出力 (Residual output) [V0]	Within ±50mV				
直線性 (Output linearity)	Within ±1%				
応答速度 (Response time)	Within 10μs (at di/dt=1f/μs)				
過渡特性 (Response performance)	Within 10%				
ヒステリシス巾 (Hysteresis voltage range)	Within 60mV				
出力温度特性 (Output Temp. Coef.)	Within ±0.1%/°C				
残留出力温度特性 (Residual output Temp. Coef.)	Within ±2mV/°C				
制御電源 (Control power supply)	±15V±5%				
消費電流 (Consumption current)	Within 20mA				
使用温度範囲 (Operating Temp.)	-10°C~+80°C				
保存温度範囲 (Storage Temp.)	-15°C~+85°C				
耐電圧 (Dielectric withstand voltage)	2500V AC 50/60Hz 1minute				
絶縁抵抗 (Insulation resistance)	Not less than 500MΩ 500V DC				

Note 1) 残留出力値はコアヒステリシス除去後の値です。
The indicated residual output is the one after the core hysteresis is removed.

特性図 Characteristics chart

HC-PDG20V4B15

時間軸 Time base: 5μs/div.

パルス電流応答特性
Pulse current response characteristic

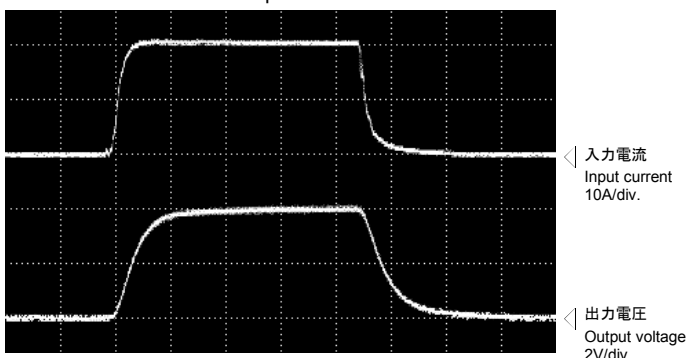

ノイズ特性 (dv/dtの影響)
Noise characteristics (Effects of dv/dt)

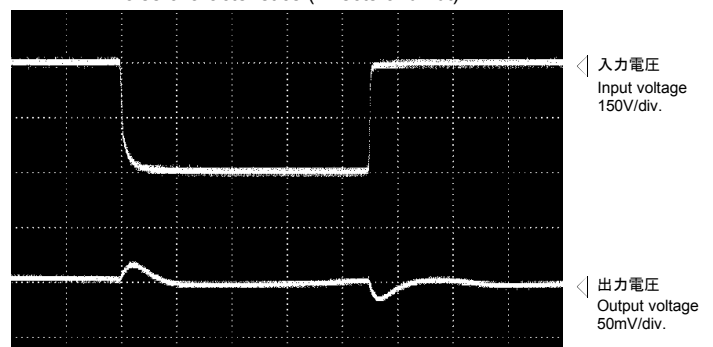

ノイズ特性 (インパルスノイズの影響)
Noise characteristics (Effects of impulse noise)

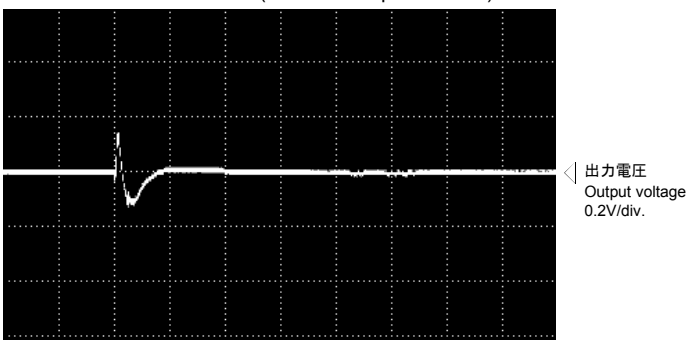

入-出力特性
Input/output characteristics

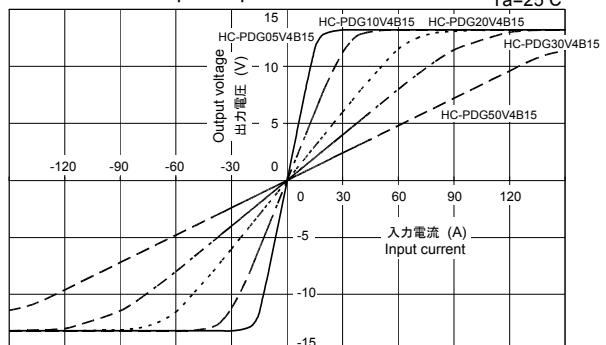

注: "◁"は0Vまたは、0Aを示します。 The marks "◁" means 0V or 0A.